

ingenico

Lane 3600

User Guide



www.ingenico.com

13-17 rue Pagès, 92150 Suresnes – France

Banks and Acquirers International Holding SAS / 814 767 216 RCS Nanterre



Contents

1. Introduction	4
2. Unpacking	5
3. Recommendations	6
3.1 Safety	6
3.2 Security of your terminal (tampering attempt detection)	7
3.3 Main Characteristics	9
3.3.1 Power characteristics	9
3.3.2 USB 5V	11
3.3.3 Shutdown mode	11
3.4 Installation & Connections	11
3.4.1 Positioning the terminal	11
3.4.2 Inserting SAM (Secure access module)	12
3.4.3 Connecting the terminal to the host	12
3.4.4 Setting the Lane/3600 on the stanpole adaptor	14
4. Daily use	15
4.1 Card reading	15
4.1.1 Swiping a card	15
4.1.2 Inserting a smart card	15
4.1.3 Reading a contactless card	15
4.2 Audio (option)	16
4.3 Camera (option)	17

5. Maintenance	18
5.1 Cleaning	18
5.1.1 Cleaning the terminal	18
5.1.2 Entretien du terminal	18
5.1.3 Wartung von Endgeräten	19
5.2 Transport and storage	19
5.3 Troubleshooting	20
6. Cables	21
7. Norms & Marking	23
7.1 Federal Communications Commission (FCC) Statement	23
7.2 Industry Canada (IC) Statement	24
7.3 Environment (WEEE, Batteries and Packa- ging)	24
7.4 Marking	25

1. Introduction

Thank you for choosing an Ingenico payment terminal.

We recommend you to read carefully this user guide: it gives you the necessary information about safety precautions, unpacking, installation and maintenance of your terminal.



WARRANTY / SECURITY

To benefit from the guarantee-related product, and to respect the security, we ask you to use only the power supply delivered in box with the product, entrusting maintenance operations only to an authorized person. Failure to comply with these instructions will void the manufacturer's responsibility.



This symbol indicates an important Warning.



This symbol indicates a piece of advice.

2. Unpacking

According to the model, the following items are included in the packaging box (including optional accessories):

- The terminal



The box may also include the following items depending on your working configuration:

- An installation guide
- Cable (specific to connectivity requirements)
- Power supply unit
- Screws to fix the main cable and the terminal



CAUTION

The power supply unit provided with your equipment is specially designed for it. Do not use any other power supply.



ADVICE

Keep the packaging. It must be re-used whenever the terminal is shipped.

3. Recommendations

3.1 Safety

Power on/ Power down - Emergency stop

To power on or power down the terminal, connect or disconnect the power supply from the electric outlet.

Power supply unit



CAUTION

Only use the power supply AC/DC provided with Lane/3600 or the power provided by a cash register limited power source (LPS).

Authorized power supply units:

Power Supply Unit Supplier	PHIHONG TECHNOLOGY Co. Ltd
Type	Desktop
Supplier reference	AM24W-080B-R
Electrical characteristics	8VDC 3A - Level VI
Ingenico part number	296276207



CAUTION

Lithium battery cell

The terminal is fitted with a lithium battery cell which is not accessible to the user. Only a qualified technician is authorized to open the unit and change this component. Risk of explosion if the battery is replaced by an incorrect type. Dispose of used battery according to the instructions.

Electrical power supply network

The electrical outlet must meet the following criteria:

- Must be installed near the equipment and easily accessible;
- Must meet standards and regulations in the country of use.

Explosion areas

Certain regulations restrict the use of radio equipment in chemical plants, fuel depots and any site where blasting is carried out. You are urged to comply with these regulations. The terminal shall be protected by a specially fitted and certified cover enabling use in proximity to a fuel pump.

Connection of headset  on audio jack



CAUTION

An excessive acoustic pressure of headset can involve deafness!

3.2 Security of your terminal (tampering attempt detection)

Your device fulfils current applicable PCI PTS security requirements. Upon receipt of your terminal you should check for signs of tampering of the equipment. It is strongly advised that these checks are performed regularly after receipt. You should check, for example: that the keypad is firmly in place; that there is no evidence of unusual wires that have been connected to any ports on your terminal or associated equipment, the chip card reader or any other part of your terminal. Such checks would provide warning of any unauthorised modifications to your terminal, and other suspicious behaviour of individuals that have access to your terminal.

Your terminal detects any “tampered state”. In this state the terminal will repeatedly flash the message “Alert Irruption!” and further use of the terminal will not be possible. If you observe the “Alert Irruption!” message, you should contact the terminal helpdesk immediately.

You are strongly advised to ensure that privileged access to your terminal is only granted to staff that have been independently verified as being trustworthy.

The terminal must never be put in or left at a location where it could be stolen or replaced by another device.



Warranty label

(on the bottom side of the terminal)



WARNING

If the warranty label is torn or removed, the warranty will be void.



CAUTION

Positioning of the Lane/3600 on check stand must be in such a way to make cardholder PIN (Personal Identification Number) spying infeasible.

Installing device on an adjustable stand must be in such a way that consumers can swivel the terminal sideways and/or tilt it forwards/backwards to a position that makes visual observation of the PIN-entry process difficult.

Positioning of in-store security cameras such that the PIN-entry keypad is not visible. NEVER ask the customer to divulge their PIN Code. Customers should be advised to ensure that they are not being overlooked when entering their PIN Code.



CAUTION

This equipment may not be modified, altered or changed in any way without signed written permission from Ingenico

3.3 Main Characteristics

Weight (Poids, Gewicht)	224g (7.9 oz) for Standard version 231g (8.1 oz) for Full Option version
Size (dimensions, Maße)	167 (L) x 82 (W) x 40 (H) mm
Display	2.8" backlit LCD, QVGA (800 × 480 pixels)

Operating conditions

Ambient temperature	from 0°C to +45°C
Max relative humidity	85% RH non-condensing at +40°C
Max altitude	2000 m

Storage conditions

Storage temperature	-20°C, +55°C
Max relative humidity	85% at +55°C

3.3.1 Power characteristics

Power supply units

The Lane/3600 can be powered by several ways:

- An external power supply unit (8-12VDC)
- By POE (Power over Ethernet) through an accessory that will provide 10VDC to the terminal
- By USB (5VDC or 12VDC)

The characteristics for each type of power supply are detailed hereafter.

Power supply unit

Model Name	296276207 AM24W-080B-R
Size (l x w x h)	120 × 50 × 31.4 mm
Class	Level VI IEC62368
Input voltage	AC 100-240V 50-60Hz
Output voltage	DC 8V 3A



WARNING

The power supply unit provided with your equipment is specially designed for this Ingenico terminal. Do not use any other power supply. The use of a power supply with apparently similar voltage/current characteristics may damage your terminal.



AVERTISSEMENT

Dans le cas où vous choisiriez d'utiliser un bloc d'alimentation, assurez-vous de n'utiliser que le bloc d'alimentation qui a été conçu spécialement pour votre terminal. N'utilisez pas d'autre bloc d'alimentation. L'emploi d'un bloc d'alimentation présentant des caractéristiques apparemment similaires de tension/intensité peut endommager votre terminal.



WARNHINWEIS

Nur das Netzteil, das speziell für Ihr Gerät ausgelegt wurde, benutzen. Benutzen Sie kein anderes Netzteil. Die Benutzung eines Netzgeräts mit scheinbar ähnlicher Spannung/Stromstärke kann zur Beschädigung Ihres Terminals führen.

3.3.2 USB 5V

In case power is 5VDC from USB, the power is optimized to save as much power as possible. Some features are deactivated (like Ethernet) others are reduced (backlights and buzzer).

3.3.3 Shutdown mode

A new feature has been introduced on Lane/3600. By pressing the Green button it enters in Shutdown mode. The product is powered off and it need to be powered ON again to restart.

3.4 Installation & Connections

3.4.1 Positioning the terminal

Place the terminal with an easy access to an electrical outlet. Place the terminal away from any heat source and protected from dust, vibrations and electromagnetic radiations (away from video terminals, PC, anti-shoplifting barriers ...). The terminal is exclusively made for indoor use. The Lane/3600 device may be mounted on a flat surface, wall, or customer stand.



CAUTION

Do not place the Lane/3600 device on a PC monitor, adjacent to an electronically active security tag deactivation system, or near other sources of magnetic fields.

The Lane/3600 device must be at least 30 centimeters (12 inches) away from an electronically active type of security tag deactivation pad. There are two types of security tag deactivation systems:

- An electronically active system sends out a powerful and potentially disruptive signal to deactivate the security tag. If the Lane/3600 device is placed too close to the system's pad, or placed above the pad, the product may not work properly.
- A passive system is a permanent magnet type that does not send out a signal. This type should not affect the Lane/3600 device.

3.4.2 Inserting SAM (Secure access module)

Power off the terminal, remove the SAM door on the back side of the Lane/3600 and then insert the SAM



CAUTION

Before starting, switch off the terminal by disconnecting the power supply.



WARNING

During this operation, it is necessary to be in an ESD protected environment. As this is not very easy, it is recommended to make this operation using ESD shoes for example

3.4.3 Connecting the terminal to the host



CAUTION

Connecting must be made when power supply unit is not plugged in the cable.



- Flip the terminal. There is one port on the back for power and communications.
- Connect the cable on the terminal.
- Connect the other end to the power supply unit and a Host (PC / cash register...).
- Plug the power supply into the mains.



WARNING

The main port at the back must not be used to connect an video cable.
Only connect cables provided by Ingenico.

Note: 2 screws can be added (M2.5 × 8) to hold more firmly the cable to the terminal.

3.4.4 Setting the Lane/3600 on the stand-pole adaptor

Install the terminal on a flat surface is not possible on the Lane/3600 as is. It is designed to be fitted on a standpole adaptor.
The specific pattern by Ingenico is also available on the Lane/3600.

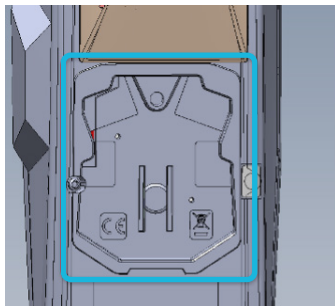

To fit the Lane/3600 to the stand pole adaptor, it only requires to slide down the Lane/3600 until a click sound:



The Lane/3600 is now ready to use:

4. Daily use

4.1 Card reading

4.1.1 Swiping a card

Insert the card manually in the reader, magnetic stripe facing the main body of the terminal, and slide the card from the rear to the front in a continuous motion for best results.



Swipe the card with constant speed, neither too slowly nor too fast, to maximize the reading efficiency and avoid annoying repetitions.

4.1.2 Inserting a smart card

- Chip cards should be inserted into your terminal as illustrated with the chip facing up and into the card reader.



4.1.3 Reading a contactless card

- Bring the card to the active zone above the contactless logo (at about 1cm).
- Keep the card close to the contactless logo during the transaction.



Your contactless terminal provides four contactless status lights located above the contactless logo.

- When a contactless transaction is started the first (left hand) status light will be lit steadily; this indicates that the contactless is in use but a card is not being read.
- When a contactless card is presented to the contactless active zone during a transaction the second, third and fourth status lights will be lit in turn. The card read is successful when all four status lights are lit and a confirmation tone can be heard.



CAUTION

Do not stick any label onto the contactless active zone. It can decrease seriously contactless efficiency



CAUTION

Avoid metallic parts around the contactless area.

4.2 Audio (Option)

A speaker is available there is also an Audio jack. When a headset is plugged in, there is no more sound from the speaker

- The audio jack  is located close to the cable.
- This option is not designed to play music, but to facilitate the use by blind people.
- The jack is 3.5mm, 32 ohms impedance.

4.3 Camera (Option)

Camera is on the back side of the product. It is necessary to install Lane/3600 on a standpole to use the Camera.

The Camera of Lane 3600 can read QR codes and Bares codes.

Among the barecode the camera supports the reading of following barcodes :

- EAN bare codes (European Article Number) with 13 digits
- UPC (Universal Product Code) with 12 digits
- Code 39 which can combine and digits, letters, special characters (+, -,

Here are the dimensions of the codes that Lane 3600 Camera can read :

- QR codes : min 1cm max 6 cm
- Bare codes : min 2cm max 6 cm

A Red Light is on to show the area where to scan the code.

5. Daily Maintenance

5.1 Cleaning

5.1.1 Cleaning of the terminal



CAUTION

Before making any operations of maintenance in the terminal, make sure that the power supply is disconnected.

First of all, unplug all the wires from the terminal.
Good rules for proper cleaning of the terminal are:

Follow : Cleaning instructions for Ingenico Payment Terminals
www.ingenico.com/cleaning-instruction-terminals/

- Do not clean the electrical connections.
- Do not use in any case, solvents, detergents or abrasive products: those materials might damage the plastic or electrical contacts.
- Avoid exposing the terminal to the direct rays of the sun.
- Do not put anything into the slot of the smart card reader

5.1.2 Entretien du terminal



ATTENTION

Assurez-vous que tous les câbles sont bien débranchés du terminal avant toute intervention de maintenance sur le terminal

Avant tout, débranchez tous les câbles du terminal.
Pour bien nettoyer le terminal :

Suivez les méthodes de nettoyage : Cleaning for Ingenico Payment Terminals - www.ingenico.com/cleaning-instruction-terminals/

- Ne nettoyez pas les connexions électriques.

- N'utilisez jamais de solvants, de détergents, d'alcool ou de produits abrasifs : ces produits peuvent endommager le plastique ou les contacts électriques.
- Evitez d'exposer le terminal aux rayons directs du soleil.
- N'insérez rien dans la fente du lecteur de carte.

5.1.3 Wartung von Endgeräten



ACHTUNG

Stellen Sie vor jeglicher Wartungsarbeit an dem Terminal sicher, dass die Stromversorgung unterbrochen ist

Als erstes alle Kabel vom Terminal trennen.
Regeln für eine ordnungsgemäße Reinigung des Terminals:

Folgen : Cleaning for Ingenico Payment Terminals - www.ingenico.com/cleaning-instruction-terminals/

- Keine elektrischen Anschlüsse reinigen.
- Auf keinen Fall Lösungsmittel, Waschmittel oder Scheuermittel verwenden: diese Mittel können den Kunststoff oder elektrische Kontakte beschädigen.
- Das Terminal keiner direkten Sonneneinstrahlung aussetzen.
- Nichts in den Schlitz des Chipkartenlesers einführen.



CAUTION

Before making any operations of maintenance in the terminal, make sure that the power supply is disconnected.

5.2 Transport and storage

- Use the original packaging for storage or returning the unit.
- Disconnect all cables from the terminal during the transport.

5.3 Troubleshooting

Device is not working

- Make sure that the Lane/3600 connector is fully inserted into the back of the device.
- Restart the device.
- If you have another working Lane/3600 device, swap the devices to determine if the problem is with the device, cable, POS, or power supply.
- If the Lane/3600 device is directly connected to a host, reset the host by turning it off and back on again.

Magnetic Card Reader Does Not Work Properly

- When sliding the card through the reader, make sure that the magnetic stripe on the card is facing the Lane/3600 display screen (see [Swiping a Magnetic Stripe Card](#)).
- Swipe the card at a faster or middle steady speed.
- Inspect the magnetic stripe on the card to make sure it is not scratched or badly worn.
- Security tag deactivation system could disturb the magnetic card reader
- To determine if the problem is with the card:
 - a. If your host device has a magnetic stripe reader, try swiping the card there.
 - b. If you have another working Lane/3600 device, try swiping the card there.

Smart Card Reader Does Not Work Properly

- Make sure you have inserted correctly the smart card into the smart card reader and removed the card only after the transaction.



WARNING

Changes or modifications to this device not expressly approved by the party responsible for compliance could void the user's authority to operate the equipment.

6. Cables

The terminal can be connected to the host by several ways, with optional cables:

- High speed USB device
- Ethernet
- RS232

Most of the cables used with iSC and iPP ranges are compatible with the Lane/3600.

We advise to check with your reseller their compatibility if you plan to replace an iSC480 / ISC250 / ISC Touch 250 by a Lane/3600.

Following are some examples of accessories that can be used to connect the Lane/3600. This list is not exhaustive. Please contact your reseller for more information.

- **RS232 cable (optional)**

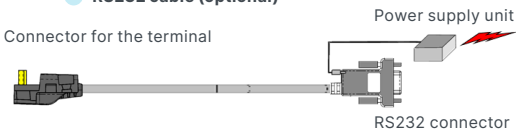

- **USB cable (optional)**

References : 296111170AC (length 2m)

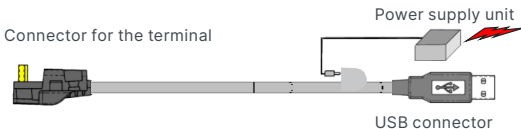

● **USB powered 12V cable (optional)**

Connector for the terminal

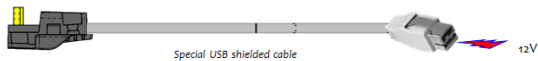

● **Ethernet cable (optional)**

Connector for the terminal



● **USB 5V - 296111170AD (optional)**

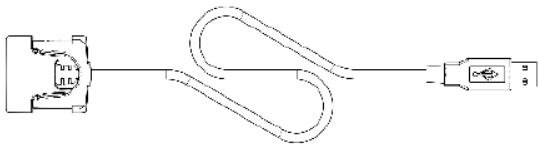

7. Norms & Marking

7.1 Federal Communications Commission (FCC) Statement

15.21

You are cautioned that changes or modifications not expressly approved by the part responsible for compliance could void the user's authority to operate the equipment.

15.105(b)

This equipment has been tested and found to comply with the limits for a Class B digital device, pursuant to part 15 of the FCC rules. These limits are designed to provide reasonable protection against harmful interference in a residential installation. This equipment generates, uses and can radiate radio frequency energy and, if not installed and used in accordance with the instructions, may cause harmful interference to radio communications. However, there is no guarantee that interference will not occur in a particular installation. If this equipment does cause harmful interference to radio or television reception, which can be determined by turning the equipment off and on, the user is encouraged to try to correct the interference by one or more of the following measures:

- Reorient or relocate the receiving antenna.
- Increase the separation between the equipment and receiver.
- Connect the equipment into an outlet on a circuit different from that to which the receiver is connected.
- Consult the dealer or an experienced radio/TV technician for help.

15.19 (a) (3)

This device complies with Part 15 of the FCC Rules. Operation is subject to the following two conditions:

- 1) This device may not cause harmful interference and
- 2) This device must accept any interference received, including interference that may cause undesired operation of the device.

7.2 Industry Canada (IC) Statement

This device complies with Industry Canada licence-exempt RSS standard(s). Operation is subject to the following two conditions:

- 1) this device may not cause interference, and
- 2) this device must accept any interference, including interference that may cause undesired operation of the device.

Le présent appareil est conforme aux CNR d'Industrie Canada applicables aux appareils radio exempts de licence. L'exploitation est autorisée aux deux conditions suivantes:

- 1) l'appareil ne doit pas produire de brouillage, et
- 2) l'utilisateur de l'appareil doit accepter tout brouillage radioélectrique subi, même si le brouillage est susceptible d'en compromettre le fonctionnement.

7.3 Environment (WEEE, Batteries and Packaging)

This product is labeled in accordance with European Directives 2012/19/EU concerning Waste Electrical and Electronic Equipment (WEEE) and 2006/66/EC concerning Batteries and Accumulators. Those provisions are requiring producers and manufacturers to become liable for take-back, treatment and recycling upon end of life of equipment and batteries.

The associated symbol means that WEEE and waste batteries must not be thrown away but collected separately and recycled.

Ingenico ensures that efficient collection and recycling schemes are set-up for WEEE and batteries according to the local regulation of your country. Please contact your resellers for more detailed information about the compliance solution in place for disposing of your old product and used batteries.

Packaging waste must also be collected separately to assure a proper disposal and recycling.

Please note that proper recycling of the electrical and electronic equipment and waste batteries will ensure safety of human health and environment.

7.4 Marking

Below, you will find the different symbols used on the product and its power supply.



The CE marking is the manufacturer's declaration that the product meets the requirements of the applicable EC directives. The CE mark is a mandatory conformity marking for certain products sold within the European Economic Area (EEA).



Waste of Electrical and Electronic Equipment (WEEE) symbol indicates that when the end-user wishes to discard this product, it must be sent to separate collection facilities for recovery and recycling. By separating this product from other household-type waste, the volume of waste sent to incinerators or land-fills will be reduced and natural resources will thus be conserved.



This logo indicates that the product operates with an alternative voltage. This symbol is followed by the ratings (voltage and current for instance).



This logo indicates that the product operates with a continuous voltage. This symbol is followed by the ratings (voltage and current for instance).



Mark indicating a power supply meets the level VI requirements.



Double insulated or class 2 electrical appliances are products that have been designed in a way so as not to require a safety connection to electrical earth (These products must NOT have a safety connection to Earth).



Indoor use symbol.

NOTES

NOTES

“This Document is Copyright © 2022 by INGENICO Group. INGENICO retains full copyright ownership, rights and protection in all material contained in this document. The recipient can receive this document on the condition that he will keep the document confidential and will not use its contents in any form or by any means, except as agreed beforehand, without the prior written permission of INGENICO. Moreover, nobody is authorized to place this document at the disposal of any third party without the prior written permission of INGENICO. If such permission is granted, it will be subject to the condition that the recipient ensures that any other recipient of this document, or information contained therein, is held responsible to INGENICO for the confidentiality of that information.

Care has been taken to ensure that the content of this document is as accurate as possible. INGENICO however declines any responsibility for inaccurate, incomplete or outdated information. The contents of this document may change from time to time without prior notice, and do not create, specify, modify or replace any new or prior contractual obligations agreed upon in writing between INGENICO and the user.

INGENICO is not responsible for any use of this device, which would be non-consistent with the present document.

All trademarks used in this document remain the property of their rightful owners.”

Your contact

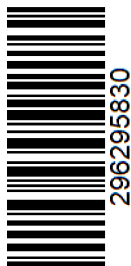

www.ingenico.com

13-17 rue Pagès, 92150 Suresnes – France

Banks and Acquirers International Holding SAS / 814 767 216 RCS Nanterre

Lane/3600
900048155 R11 000 03/0124